

Polaris



Porta battente a tre ante
due pareti fisse e un'anta battente verso l'interno e verso l'esterno.

Paroi de douche de grandes dimensions
trois panneaux avec ouverture pivotante vers l'intérieur et l'extérieur.

Big size door, shower enclosure with two fixed panels
and one inward and outward saloon door.

Frontal medidas grande una hoja fija y una abatible hacia el interior y el exterior.

Pendeltür
zwei feste Wände und eine Schwingtür nach innen und außen.

Deuren met grote afmetingen
omkeerbaar voor bepaling openingzijde. Dragende verticale en bovenliggende profielen, profielloos onderaan.

Дверь больших размеров
одна панель стационарная и две распашные створки, открывающиеся вовнутрь и наружу.



H 195 cm. - V 6 mm.

Finitura profili

Finitions des profilés_Profiles finishing _Acabado perfiles
Profilfarbe_Profil afwerkingen _Отделка профилей



**ULU
brillantato cromo**
chromé brillant
brilliant chrome
aluminio cromo
Chrom glänzend
glanzend chrom
светлый блестящий хром

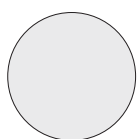

**L91
bianco opaco**
blanc mat
white matt
blanco mate
Weiß matt
wit matte
белый матовая



**L96
nero opaco**
satiné argent
silver glazed satin
satinado plata
Satinierter silber
satijn zilver
сатинованное
серебро

Finitura pannelli

Finitions des panneaux_Panels finishing _Acabado perfiles
Glasart_Paneel afwerkingen _Отделка панелей



**TR
trasparente**
transparent
transparent
transparente
Klartglas
transparent
прозрачное

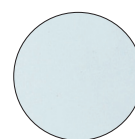

**AS
Satinato Acqua**
satiné Acqua
satin Acqua
satinado Acqua
Satiniertes Glas Acqua
satijn Acqua
сатинованное Acqua

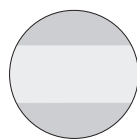

**RF
trasparente con fascia Satinata**
transparent bande sérigraphiée
transparent with serigraphy band
serigrafia franja
Klartglas siebdruck Band
transparent zeedruk band
прозрачное рисунок шелкография полоса

Porta battente a tre ante

Paroi de douche de grandes dimensions.

Big size door



Frontal medidas grande

Pendeltür

Deuren met grote afmetingen

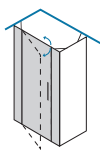
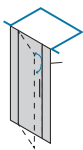
Дверь больших размеров



Z [cm]	Cod.	Massimo ingombro Z + 1,3 [cm]	A [cm]	B [cm]	C [cm]	D [cm]	 [dm ³]	 [kg]	 [n°]
97-102	B3880	98,3-100,8	23,1	58,5	51	21,5	138	38	1
102-107	B3881	103,3-105,8	25,5	52,5	51	23,9	132	38	1
107-112	B3882	108,3-110,8	25	58,5	57	23,4	142	39	1
112-117	B3883	113,3-115,8	27,5	58,5	57	25,9	146	41	1
117-122	B3884	118,3-120,8	28,6	61,2	60	27	152	43	1
122-127	B3885	123,3-125,8	30,2	63,2	62	28,6	158	45	1
127-132	B3886	128,3-130,8	32,6	63,2	62	31	162	46	1
132-137	B3887	133,3-135,8	32,2	69,2	68	30,6	172	47	1
137-142	B3888	138,3-140,8	32,6	73,2	72	31	179	49	1
142-147	B3890	143,3-145,8	35,2	73,2	72	33,6	184	51	1
147-152	B3891	148,3-150,8	37,6	73,2	72	36	188	52	2
157-162	B3892	158,3-160,8	41,6	75,2	74	40	198	54	2
167-172	B3893	168,3-170,8	44,7	79,2	78	43,1	210	60	2
177-182	B3894	178,3-180,8	46,3	86	85	44,7	225	64	2

Parete fissa per abbinamenti

Paroi fixe pour réaliser des combinaisons.

Fixed panel for combinations



Panel fijo para combinaciones

Festwand für Kombinationen

Vast paneel voor samenstellingen

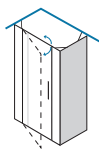
Стационарная панель для комбинирования



Z1 [cm]	Cod.	Ingombro Max Z1 + 1,8 [cm]	A [cm]	B [cm]	C [cm]	 [dm ³]	 [kg]	 [n°]
64-66,5	B3850	65,8-68,3	//	//	//	99	29	1
66,5-69	B3851	68,3-70,8	//	//	//	101	29	1
69-71,5	B3852	70,8-73,8	//	//	//	102	29	1
71,5-74	B3853	73,8-75,8	//	//	//	112	29	1
74-76,5	B3854	75,8-78,3	//	//	//	115	30	1
76,5-79	B3855	78,3-80,8	//	//	//	117	31	1
79-81,5	B3856	80,8-83,3	//	//	//	120	34	1
81,5-84	B3857	83,3-85,8	//	//	//	137	35	1
84-86,5	B3858	85,8-88,3	//	//	//	140	35	1
86,5-89	B3860	88,3-90,8	//	//	//	143	35	1
89-91,5	B3861	90,8-93,3	//	//	//	144	36	1
96,5-99	B3862	98,3-100,8	//	//	//	156	37	1
99-101,5	B3863	100,8-103,3	//	//	//	160	38	1
106,5-109	B3864	108,3-110,8	//	//	//	162	39	1
109-111,5	B3865	110,8-113,3	//	//	//	165	40	1
116,5-119	B3866	118,3-120,8	//	//	//	168	41	1
119-121,5	B3867	120,8-123,3	//	//	//	170	42	1

Le dimensioni sono in mm
 Les dimensions sont indiquées en mm
 Sizes in mm
 Las medidas son en mm
 De afmetingen zijn vermeld in mm
 Maßangaben in mm
 Mēra (mm.)

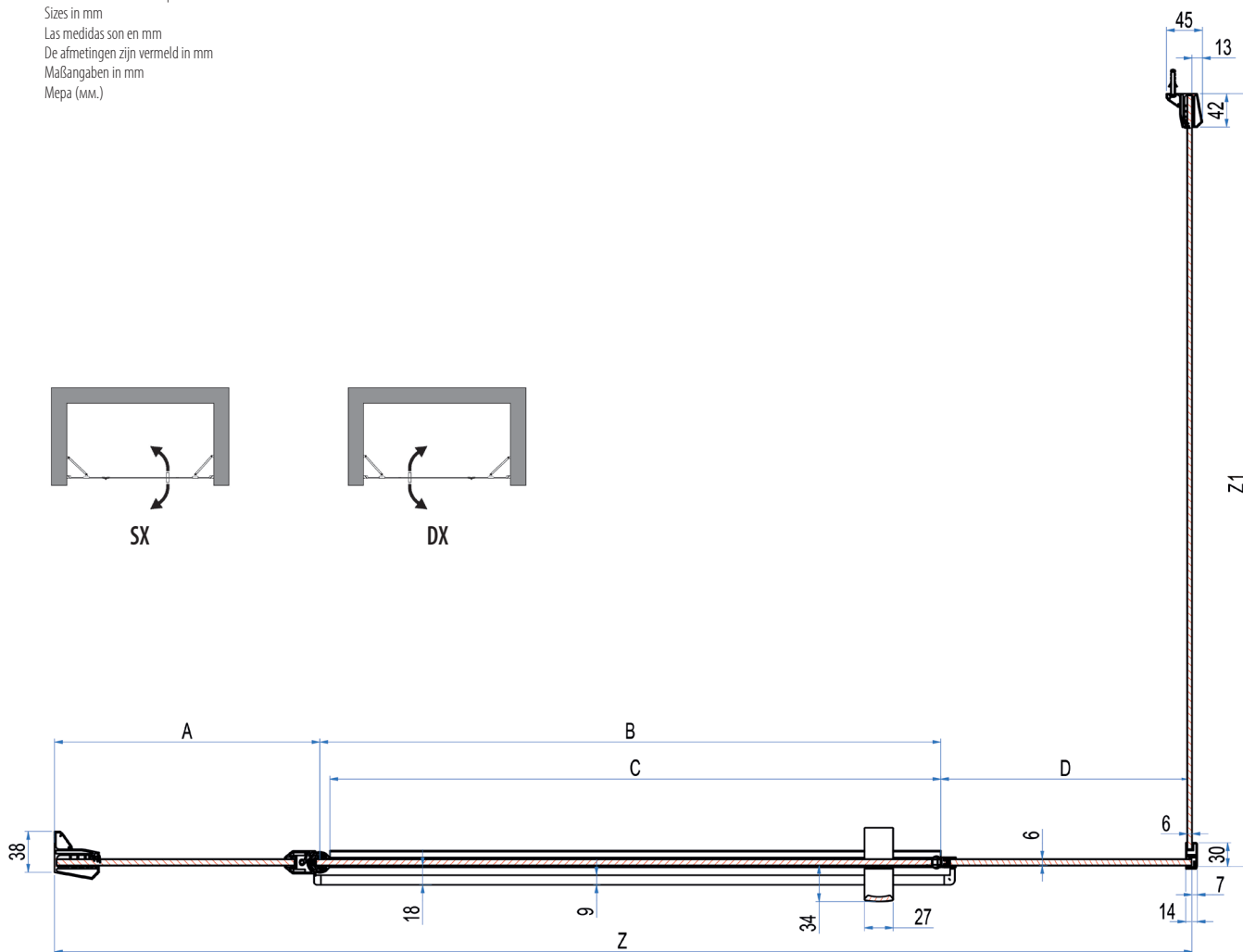
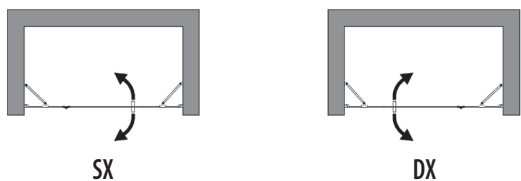

Z1+18

Z+13

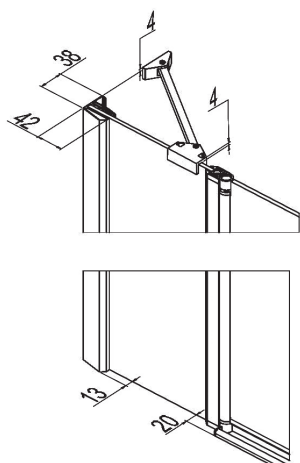
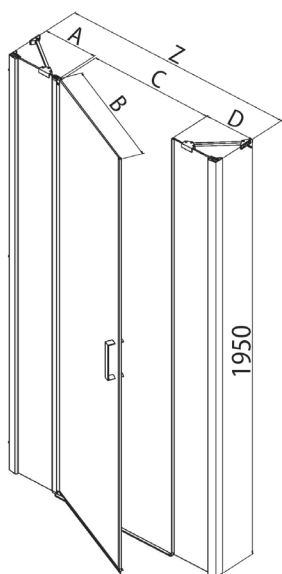

160 mm
 Interasse maniglia
 Empattement de la poignée
 Handle wheelbase
 Distancia entre ejes de la manija
 Radstand handhaben
 Handvat wielbasis
 Колесная база ручки



Prodotti Speciali - Produits Spéciaux - Special products - Productos Especiales - Sonderfertigungen - Maatwerk - Специальные Иродукты

MISURE LIMITE	Altezza max 217 cm.	//	Larghezza max 200 cm.	Larghezza min 97 cm.
MESURES LIMITES	Hauteur max 217 cm.	//	Largeur max 200 cm.	Largeur min 97 cm.
LIMITS OF MEASUREMENTS	Height max 217 cm.	//	Width max 200 cm.	Width min 97 cm.
MEDIDAS LIMITE	Altura max 217 cm.	//	Anchura max 200 cm.	Anchura min 97 cm.
GRENZMAßE	Höhe max 217 cm.	//	Breite max 200 cm.	Breite min 97 cm.
EXTREME MATEN	Hoogte max 217 cm.	//	Breedte max 200 cm.	Breedte min 97 cm.
ПРЕДЕЛЬНЫЕ РАЗМЕРЫ:	Макс. высота 217 см	//	Макс. ширина 200 см	Мин. ширина 97 см

	I								
	II								
	III								

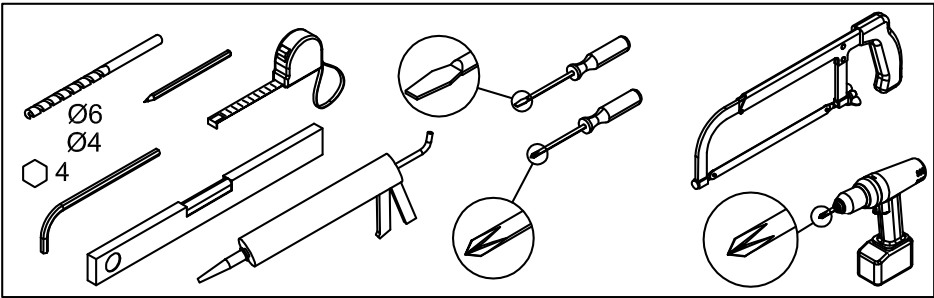
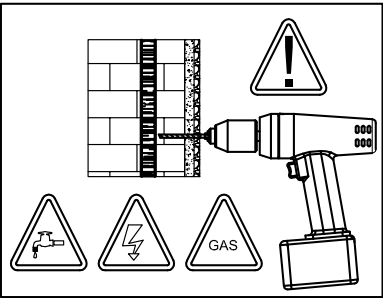
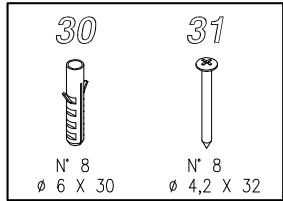
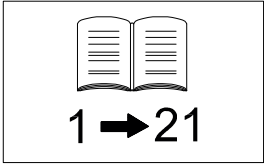
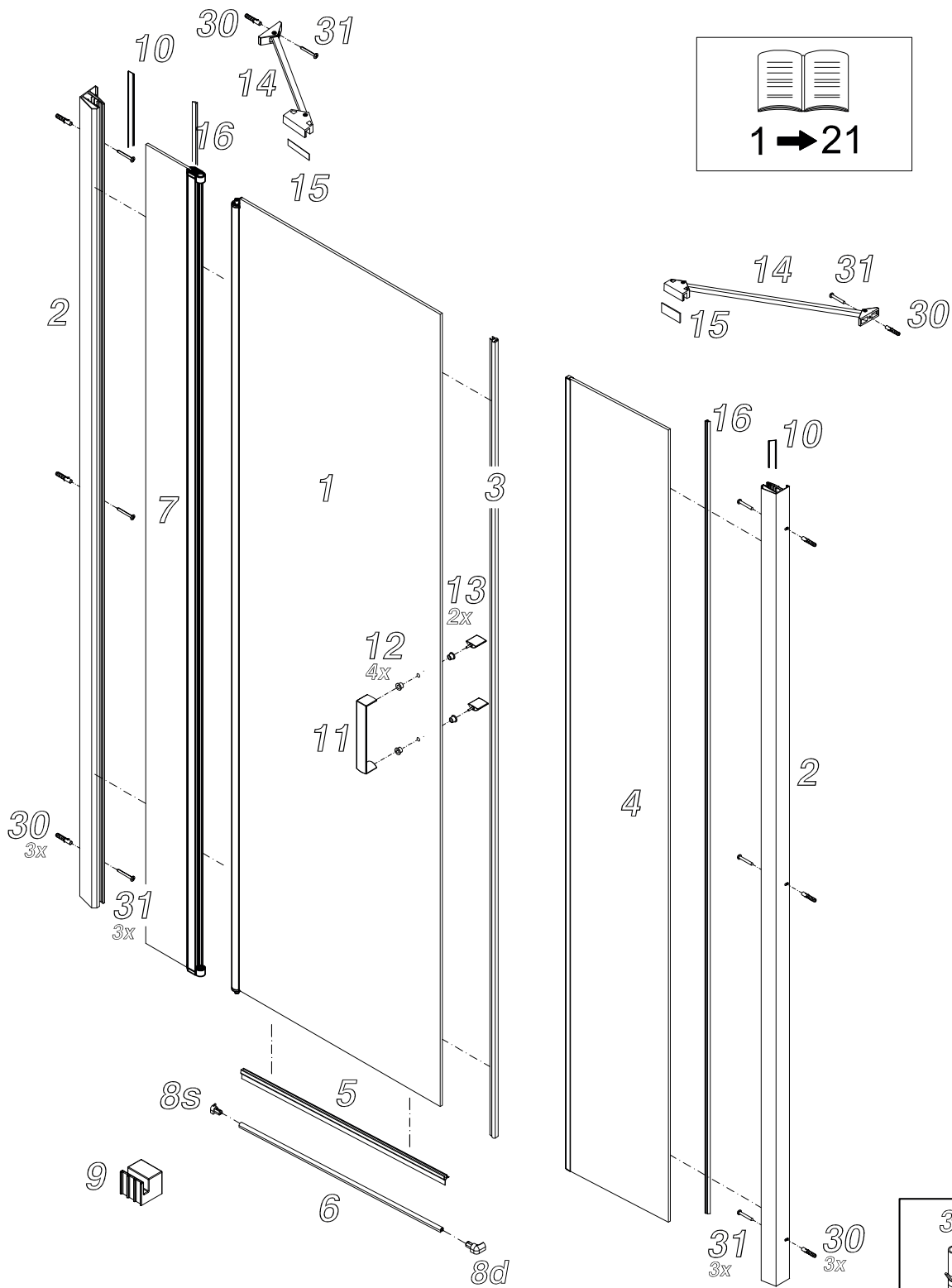

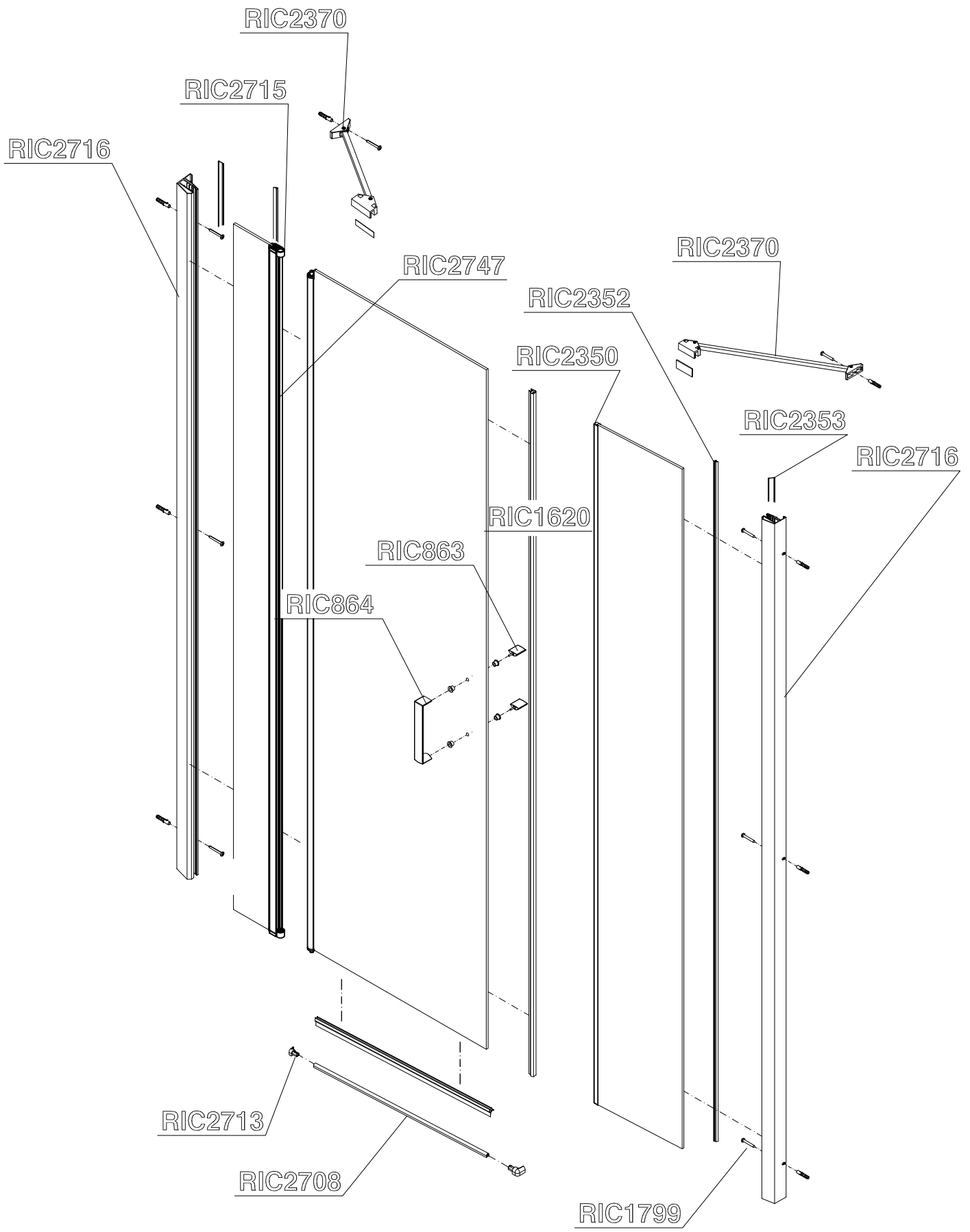

<p>RIC2716</p> <p>2 mt</p> <p>1x</p> <p>1x</p> <p>1x</p>	<p>RIC2353</p> <p>1x</p> <p>1x</p>	<p>RIC2352</p> <p>2 mt</p>	<p>RIC 2747</p>
<p>RIC2708</p> <p>1x</p> <p>1x</p>	<p>RIC1620</p> <p>2x</p>	<p>RIC2350</p> <p>1x</p> <p>1x</p>	<p>RIC1096</p> <p>1x</p>
<p>RIC1799</p> <p>6x</p> <p>4x</p> <p>6x</p> <p>4x</p>	<p>RIC2713</p> <p>1x</p> <p>1x</p> <p>1x</p> <p>1x</p> <p>1x</p>	<p>RIC2370</p> <p>1x</p> <p>1x</p> <p>1x</p> <p>1x</p>	
<p>RIC863</p> <p>2x</p> <p>1x</p> <p>1x</p>	<p>RIC864</p> <p>1x</p>	<p>RIC2715</p> <p>1x (sx)</p> <p>1x (dx)</p> <p>2x</p> <p>2x</p> <p>1x</p> <p>1x</p> <p>2x 3,5 x 32</p>	