



Parete fissa per abbinamenti,
è possibile formare cabine doccia a due o tre lati, anche misure rettangolari.

Paroi fixe pour réaliser des combinaisons
pour former des parois à deux ou trois côtés, également pour des dimensions rectangulaires. Non installable seule ou comme paroi de division.

Fixed panel for combinations
to form 2 or 3 sides shower enclosures, also in rectangular sizes. Not to be installed on its own or as dividing screen.

Panel fijo,
combinaciones posibles para la formación de cabinas de ducha de dos o tres lados, también en medidas rectangulares. No instalable para ir sola o como panel divisorio.

Festwand für Kombinationen
zur Gestaltung von Duschkabinen mit 2 oder 3 Seiten, auch regelmäßige Maße. Keine einzelne Installation.

Vaste wand voor samenstellingen,
van twee of driezijdige douchezellen, mogelijkheid tot rechthoekige maten. Niet alleen of als schidingwand plaatsbaar.

Стационарная панель для комбинирования
с душевыми кабинками. Можно создать душевые кабины с двумя или тремя сторонами, а также с прямоугольными размерами. Не устанавливается одиночно или как перегородки.



H 195 cm. - V 6 mm.

Finitura profili

Finitions des profilés_Profiles finishing _Acabado perfiles
Profilfarbe_Profiel afwerkingen _Отделка профилей

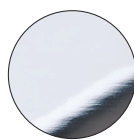

ULU
brillantato cromo
chromé brillant
brilliant chrome
aluminio cromo
Chrom glänzend
glanzend chroom
светлый блестящий хром

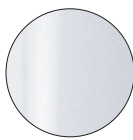

L01
bianco
blanc
white
blanco
Weiß
wit
белый

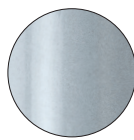

SAR
satinato argento
satiné argent
silver glazed satin
satinado plata
Satinert Silber
satijn Zilver
сатинированное серебро

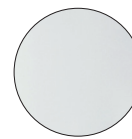

TR
trasparente
transparent
transparent
transparente
Klarglas
transparent
прозрачное



ST
Stampato
granité
frostado
estampado
Bedrucktes Glas
gemarteld
узорчатое

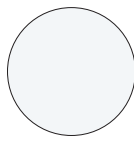

L91
bianco opaco
blanc mat
matt white
blanco mate
Matt Weiß
wit matte
белый Матовая

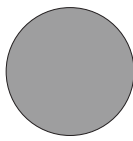

L95
grigio opaco
gris mat
matt grey
gris mate
Matt Grau
grijs matte
серый Матовая



L96
nero opaco
noir mat
matt black
negro mate
Matt Schwarz
zwart matte
черный Матовая

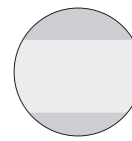

RF
trasparente con fascia Satinata
transparent bande sérigraphiée
transparent with serigraphy band
serigrafia franja
Klarglas siebdruck Band
transparent zeefdruk band
прозрачное рисунок шелкография полоса

Parete fissa per abbinamenti

Paroi fixe pour réaliser des combinaisons



Fixed panel for combinations

Panel fijo para combinaciones

Festwand für Kombinationen

Vaste wand voor samenstellingen

Стационарная панель для комбинирования

Z [cm]	Cod.	A [cm]	B [cm]	C [cm]	 [dm ³]	 [kg]	 [n°]
67-69	B0924	//	//	//	116	23	1
70-72	B0925	//	//	//	117	23,5	1
75-77	B0960	//	//	//	118	24	1
77-79	B0926	//	//	//	122	25	1
80-82	B0927	//	//	//	124	26	1
87-89	B0928	//	//	//	130	27	1
90-92	B0961	//	//	//		29	1
97-99	B0929	//	//	//	136	30	1

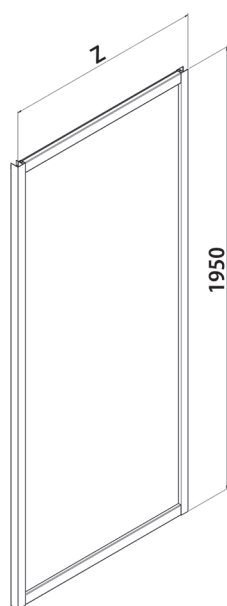

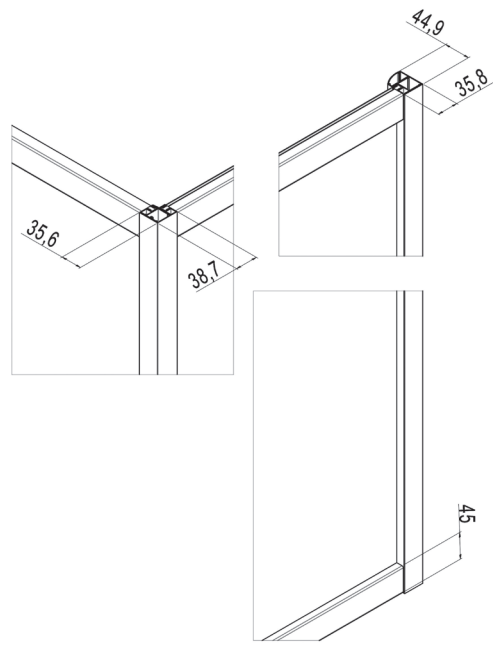
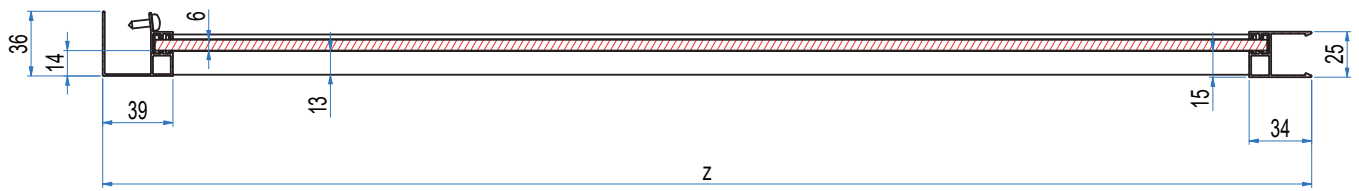



Prodotti Speciali - Produits Spéciaux - Special products - Productos Especiales - Sonderfertigungen - Maatwerk - Специальные Иродукты

MISURE LIMITE	Altezza max 200 cm.	//	Larghezza max 130 cm.	Larghezza min 50 cm.
MESURES LIMITES	Hauteur max 200 cm.	//	Largeur max 130 cm.	Largeur min 50 cm.
LIMITS OF MEASUREMENTS	Height max 200 cm.	//	Width max 130 cm.	Width min 50 cm.
MEDIDAS LIMITE	Altura max 200 cm.	//	Anchura max 130 cm.	Anchura min 50 cm.
GRENZMAßE	Höhe max 200 cm.	//	Breite max 130 cm.	Breite min 50 cm.
EXTREME MATEN	Hoogte max 200 cm.	//	Breedte max 130 cm.	Breedte min 50 cm.
ПРЕДЕЛЬНЫЕ РАЗМЕРЫ:	Макс. высота 200 см	//	Макс. ширина 130 см	Мин. ширина 50 см

	I								
	II								
	III								

B0980-0990
B0944-0948
B0901-0904
B0916-0923
B0930-0934
B0907-0911
B0952-0954

1

2
2x

3
2x

2



N°2
ø 3.9x13

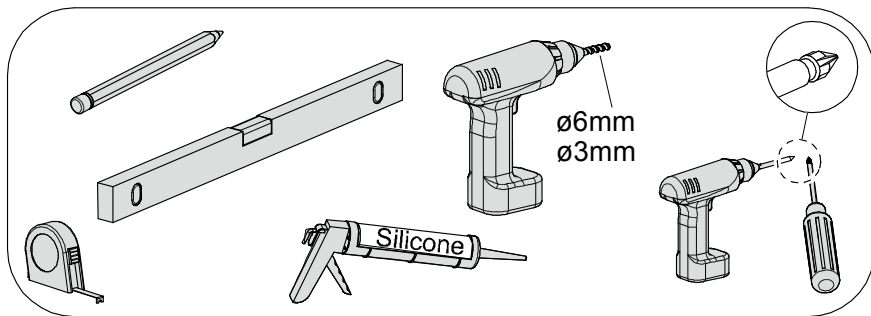
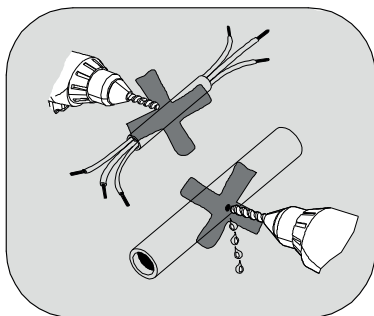

ø6mm
ø3mm

RIC1799

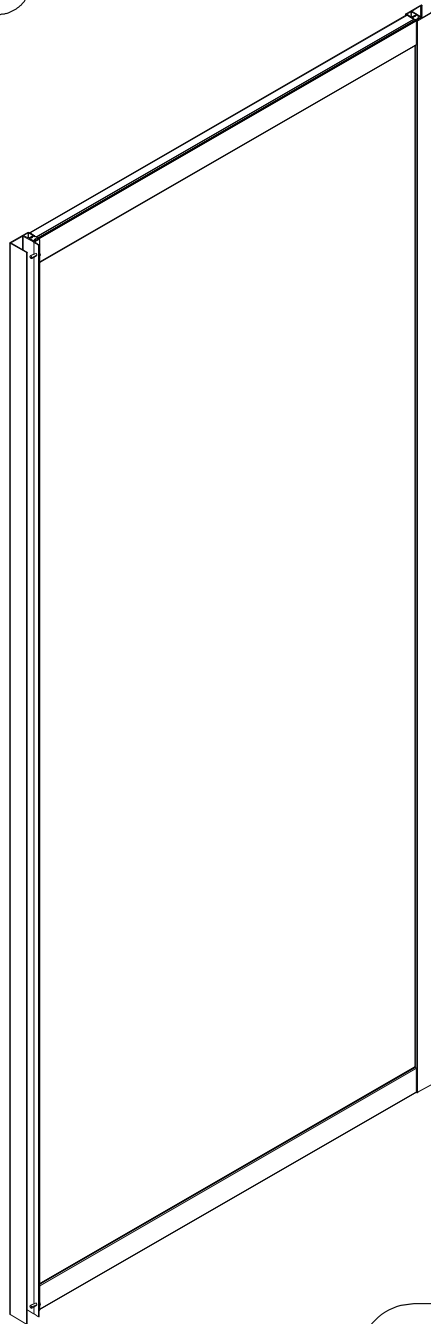

RIC1798
1x

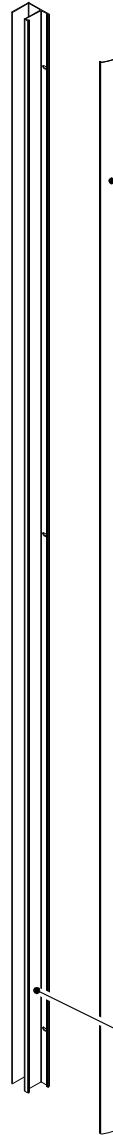

RIC2233
1x

RIC 1799

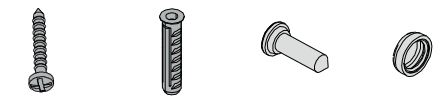

6X

6X

4X

4X

RIC 1798

1X



RIC 2233

1X

