

Flex



Penisola a tre lati

con antine a soffietto ripiegabili sia all'interno che all'esterno con snodi a 180°.

Paroi de douche à trois côtés composés de panneaux pliants

Ouverture par panneaux pliants tant vers l'intérieur que vers l'extérieur avec articulations à 180°.

Three sides corner enclosure with bifolding panels

Folding opening inwards and outwards with hinges at 180°.

Mampara angular en tres lados con hojas plegables

Abertura con panel plegable hacia el interior o el exterior con articulaciones a 180°.

U-Kabine

Türen mit schmalen Faltflügeln, die um 180° nach außen und nach innen geklappt werden können.

Driezijdige hoekuitvoering met samenvouwbare panelen

Opening met kleine op 180° naar binnen en naar buiten samenvouwbare panelen.

Трёхсторонняя угловая конструкция со складными

створками, складывающимися вовнутрь и наружу, с шарнирными соединениями в 180°.



H 100 cm. - V 3 mm.

Finitura profili

Finitions des profilés_Profiles finishing _Acabado perfiles
Profilfarbe_Profiel afwerkingen _Отделка профилей

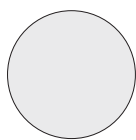

L01
bianco
blanc
white
blanco
Weiß
wit
белый

Finitura pannelli

Finitions des panneaux_Panels finishing _Acabado perfiles
Glasart_Paneel afwerkingen _Отделка панелей



TR
trasparente
transparent
transparent
transparente
Klarglas
transparent
прозрачное

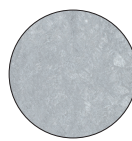

SE
Setola
Setola
Setola
Setola
Setola
Setola

Penisola a tre lati con antine a soffietto ripiegabili

Paroi de douche à trois côtés composés de panneaux pliants



Three sides corner enclosure with bifolding panels

Mampara angular en tres lados con hojas plegables

U-Kabine

Driezijdige hoekuitvoering met samenvouwbare panelen

Трехсторонняя угловая конструкция со складными створками

Z [cm]	Cod.	A [cm]	B [cm]	B1 [cm]	C [cm]	D [cm]	E [cm]	F [cm]	G [cm]	H [cm]	 [dm³]	 [kg]	 [n°]
79-83	B3636	36,5	34,5	6,8-10,8	80	38,5	10-14	9,5-13,5	40,5	42	63	15	1
87-91	B3638	40,5	38,5	6,8-10,8	90	43,5	10-14	9,5-13,5	45,5	47	70	18	1

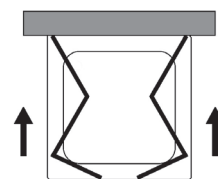
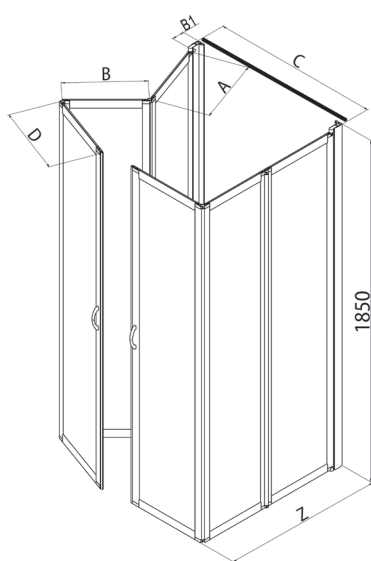

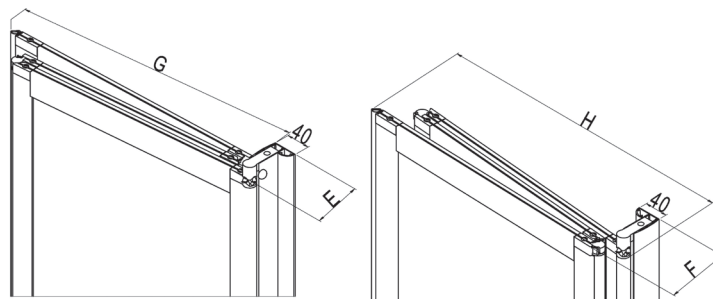
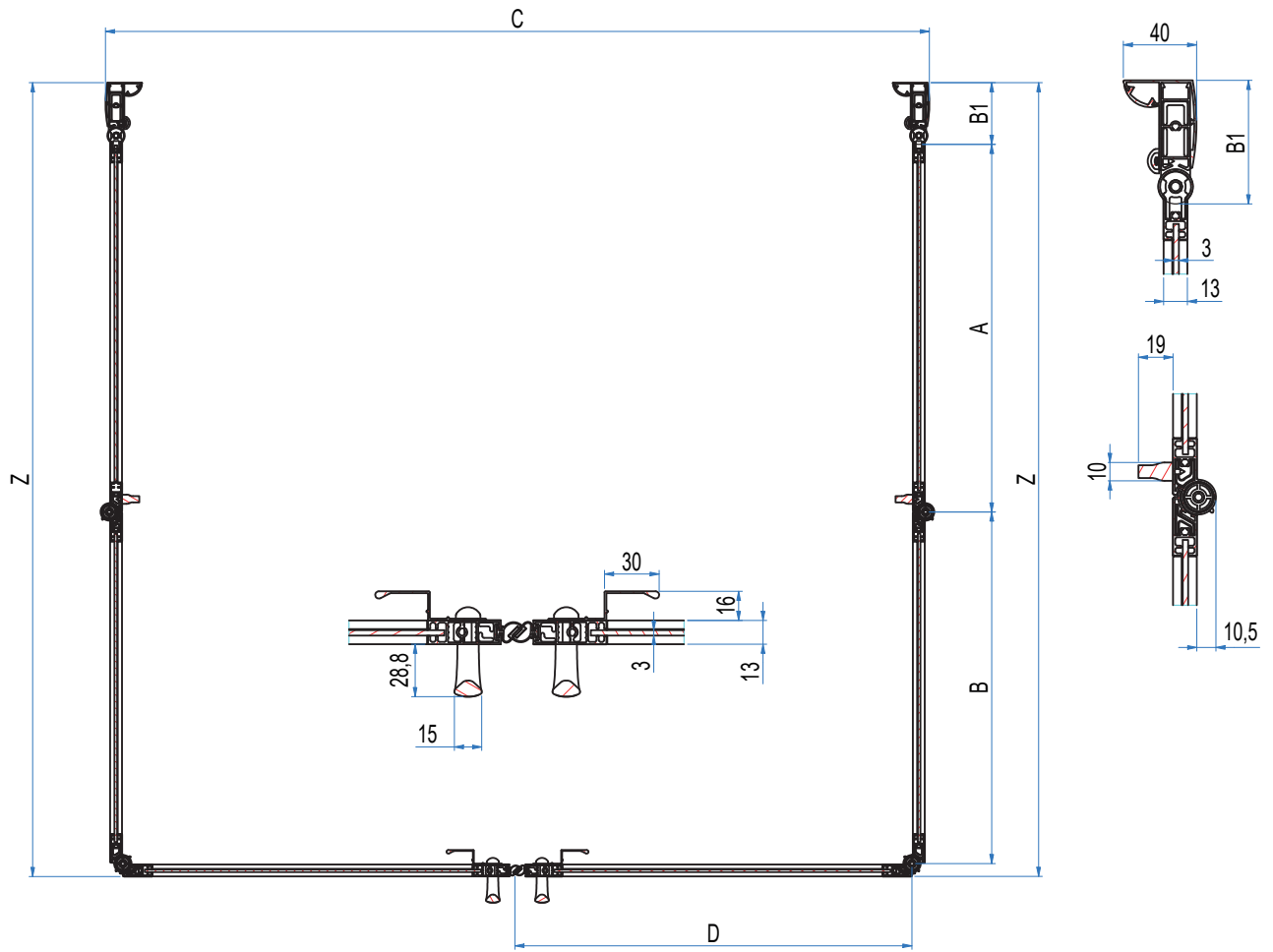

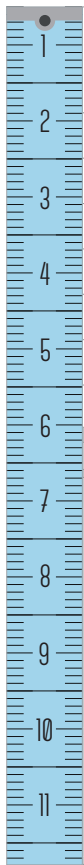

Prodotti Speciali - Produits Spéciaux - Special products - Productos Especiales - Sonderfertigungen - Maatwerk - Специальные Иродукты

MISURE LIMITE	Altezza max 100 cm.	Altezza min 50 cm.	Larghezza max 100 cm.	Larghezza min 36 cm.
MESURES LIMITES	Hauteur max 100 cm.	Hauteur min 50 cm.	Largeur max 100 cm.	Largeur min 36 cm.
LIMITS OF MEASUREMENTS	Height max 100 cm.	Height min 50 cm.	Width max 100 cm.	Width min 36 cm.
MEDIDAS LIMITE	Altura max 100 cm.	Altura min 50 cm.	Anchura max 100 cm.	Anchura min 36 cm.
GRENZMAßE	Höhe max 100 cm.	Höhe min 50 cm.	Breite max 100 cm.	Breite min 36 cm.
EXTREME MATEN	Hoogte max 100 cm.	Hoogte min 50 cm.	Breedte max 100 cm.	Breedte min 36 cm.
ПРЕДЕЛЬНЫЕ РАЗМЕРЫ:	Макс. высота 100 см	Мин. высота 50 см	Макс. ширина 100 см	Мин. ширина 36 см

	I								
	II								
	III								

Cod. 3532-3533-3534-3535-3536-
3537-3538-3636-3638

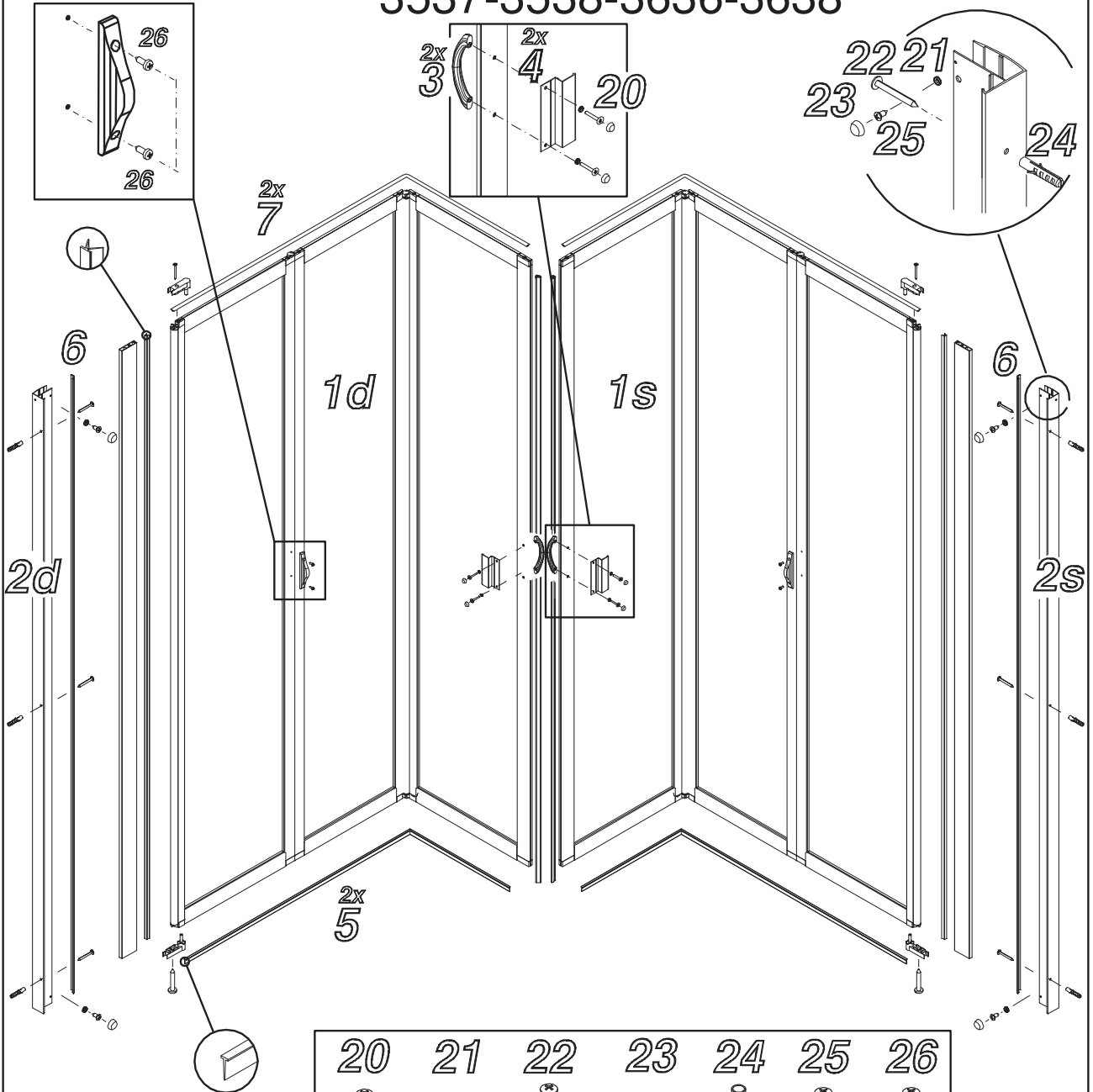

20	21	22	23	24	25	26
N° 4 M4 X 20	N° 10	N° 6 ø 3.9 X 38	N° 10	N° 6 ø 6 X 30	N° 6 ø 3.9 X 13	N° 4 ø 2.9 X 9.5

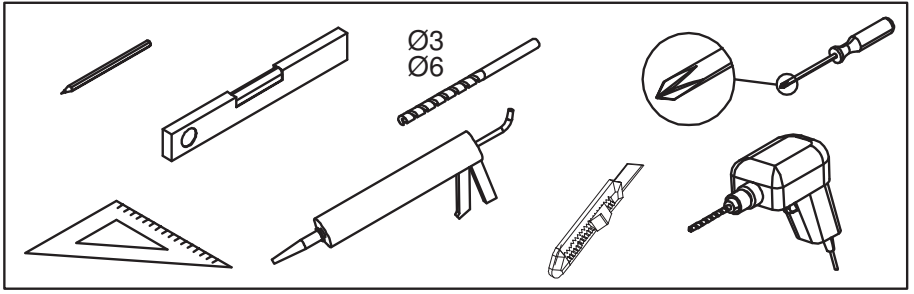
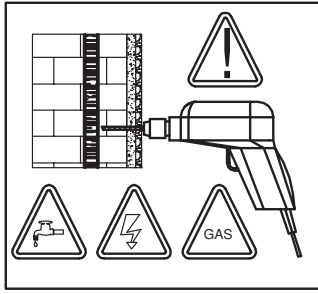

Cod. 3532-3533-3534-3535-3536-
3537-3538-3636-3638

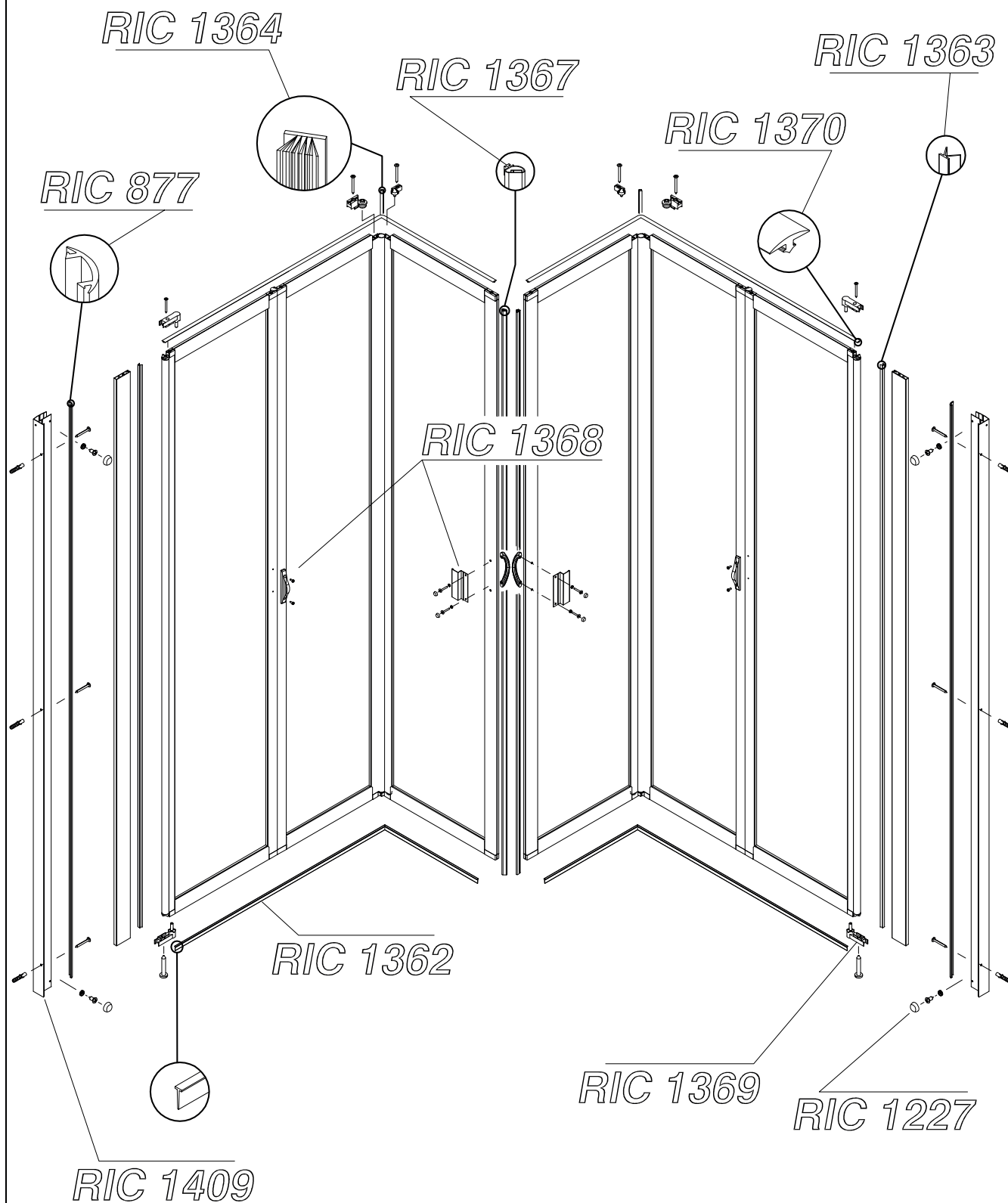

RIC 1367

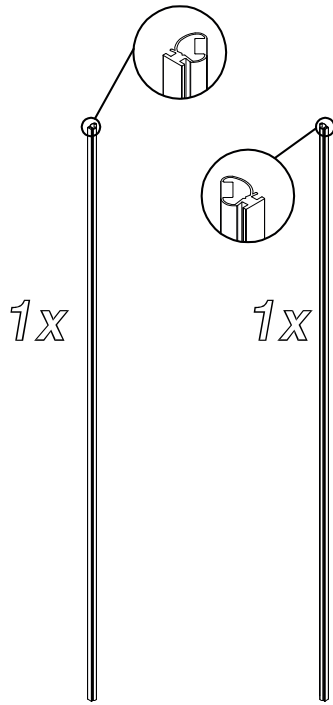

RIC 1364

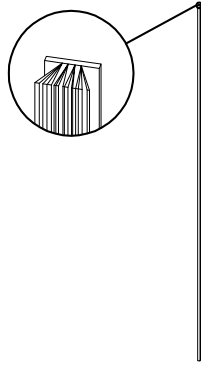

RIC 1363

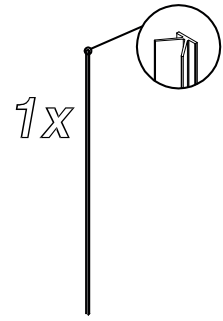

RIC 1370
(cod. 3636-3638)

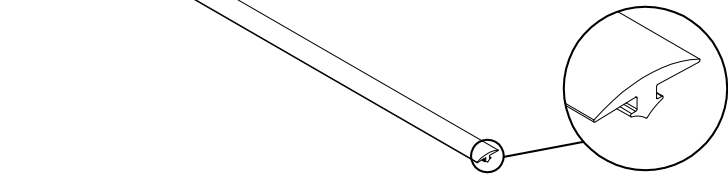

RIC 1409

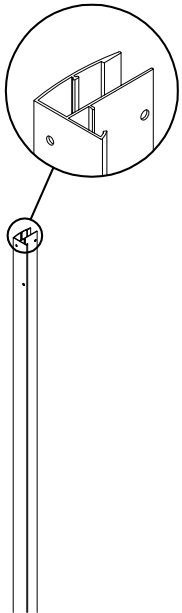

RIC 877

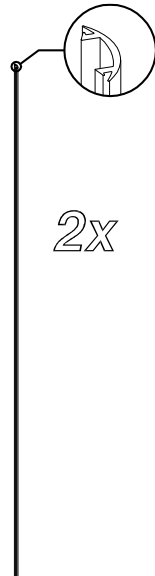

RIC 1368

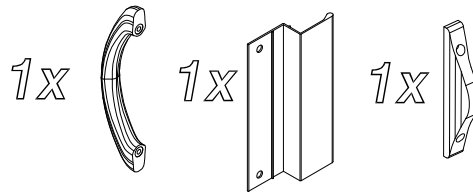

2x



2x

2x



2x

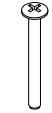

Ø 2.9 X 9.5

M4 X 20

6x



Ø 6 X 30

RIC 1227

6x



Ø 3.9 X 38

8x



6x



2x



Ø 3.9 X 9.5

RIC 1362

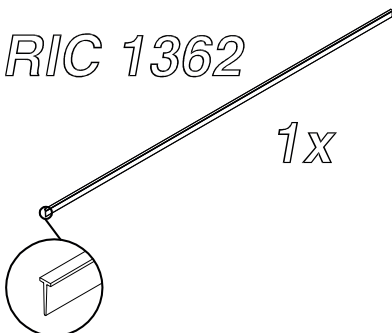

RIC 1369

8x



Ø 3.9 X 25

2x



2x

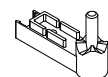

2x

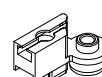

2x

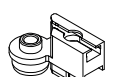

2x

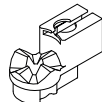

2x

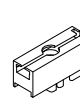

2x

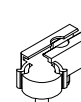

2x

