



Parete fissa per abbinamenti,

è possibile formare cabine doccia a due o tre lati, anche misure rettangolari. Profili superiori e verticali portanti, assenza di quelli inferiori. Non installabile singolarmente o come divisorio.

Paroi fixe pour réaliser des combinaisons

pour former des parois à deux ou trois côtés, également pour des dimensions rectangulaires. Profils supérieurs et verticaux portants, absence de profilé inférieur.

Fixed panel for combinations,

to form 2 or 3 sides shower enclosures, also in rectangular sizes. The structure is build of vertical and top profiles, absence of bottom profiles. Panel available for coupling with other products only.

Panel fijo,

combinaciones posibles para la formación de cabinas de ducha de dos o tres lados, también en medidas rectangulares. La estructura está formada por perfiles verticales y superiores, ausencia de perfiles inferiores.

Festwand zum Kombinieren mit verschiedenen Türvarianten.

Ohne untere Führungsschiene, für bodengleichen Einstieg. Panel nicht installiert einzeln oder als Teiler.

Vaste wand voor samenstellingen,

van twee of driezijdige douchezellen, mogelijkheid tot rechthoekige maten. Dragende verticale en bovenliggende profielen, profielloos onderaan.

Стационарная панель для комбинирования,

можно создать душевые кабины с двумя или тремя сторонами, а также с прямоугольными размерами. Несущие верхние и вертикальные профили, нижние отсутствуют.

5 anni di garanzia_ Garantie 5 an_ 5 Years Warranty_ Garantie De 5 Años_ 5 Jahre Garantie_ 5 Jaar Garantie_ ЛЕТ ГАРАНТИЯ

5



H 200 cm. - V 6 mm.

Profili in alluminio / Finitions profilés en aluminium / Profiles finishing / Acabado perfiles / Glasart / Afwerking panelen veiligheidsglas / Отделка панелей из закаленного стекла



ULU
Brillantato cromo / Chromé brillant / Brilliant chrome / Cromo brillante / Satiniert silber / Glanzend chrom / сатинированное серебро

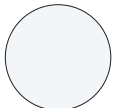

L90
Artic opaco / Artic mat / Artic / Artic / Artic / Artic matte / artic



L92
Sailor blue opaco / Sailor blue mat / Sailor blue / Sailor blue / Sailor Blue / Sailor blue matte / Sailor blue



L96
Nero opaco / Noir mat / Black / Negro / Schwarz / Zwart matte / черный

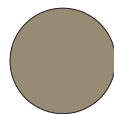

L99
Tortora opaco / Tortora mat / Tortora / Tortora / Satijn zilver / tortora matte / tortora

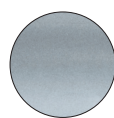

SAR
Satinato Argento / satiné argent / silver glazed satin / satinado plata / Satiniert silber / satijn zilver / светлый блестящий хром

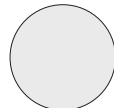

L91
Bianco opaco / Blanc mat / White / Blanco / Weiß / Wit matte / белый

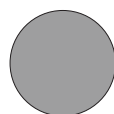

L95
Grigio opaco / Gris mat / Grey / Gris / Grau / Grijs matte / серый

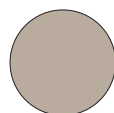

L98
Sabbia opaco / Sable mat / Sand / Arena / Sand / zandkleur matte / песок

Finitura profili / Finitions des profilés / Profiles finishing / Acabado perfiles / Profilarfarbe / Profiel afwerkingen / Отделка профилей

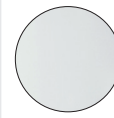

TR
Trasparente / Transparent / Transparent / Transparente / Klarglas / Transparant / прозрачное



TG
Trasparente grigio / Transparent Gris / Transparent Grey / Transparente gris / Klarglas Grau / Transparant Grijs / серое прозрачное

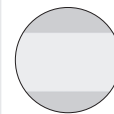

RF
Trasparente con fascia satinata H 100 cm / Transparent avec bande sérigraphiée H. 100 cm. / transparent serigraphy band / Cristal de espejo / Klarglas siebdruck Band / transparant met zeefdruk band H. 100 cm / прозрачное рисунок шелкография полоса H. 100 cm.



SY
Vetro a specchio / Verre miroir uniquement sur les panneaux fixes, les panneaux coulissants restent TR / Mirrored glass / transparente serigrafia franja / Speiegelglas / Spiegeld glas / стекло зеркало ко на неподвижных панелях, скользящих панелях TR

Parete fissa per abbinamenti

Paroi fixe pour réaliser des combinaisons

Fixed panel for combination

Panel fijo para combinaciones

Festwand für Kombinationen

Vaste wand voor samenstellingen

Стационарная панель для комбинирования



Trattamento anticalcare di serie compreso nel prezzo

Traitement anti-calcaire inclus dans le prix



Anti-limescale treatment included in the price

Tratamiento antical incluido en el precio

Gegen Kalkablagerungen schützende Glasbehandlung im Preis inbegriffen

Anti-kalkafwerking inbegrepen in de prijs

Средство от известкового налета включено в цену

Z [cm].	Cod.	A [cm]	B [cm]	C [cm]	 [dm ³]	 [kg]	 [n°]
67-69	B8822	//	//	//	99	24	1
70-72	B8823	//	//	//	105	26	1
72-74	B8824	//	//	//	113	27	1
77-79	B8825	//	//	//	119	29	1
87-89	B8826	//	//	//	124	30	1
97-99	B8827	//	//	//	129	31	1

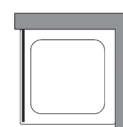
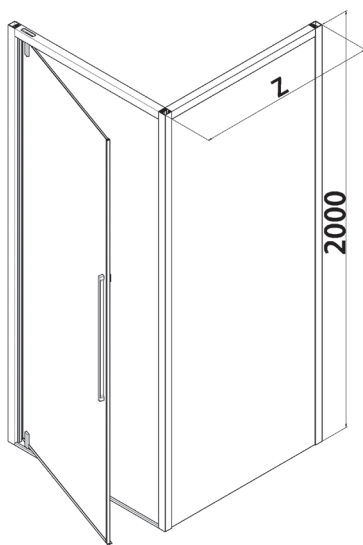

SX



DX

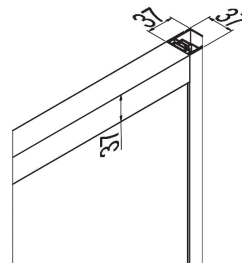
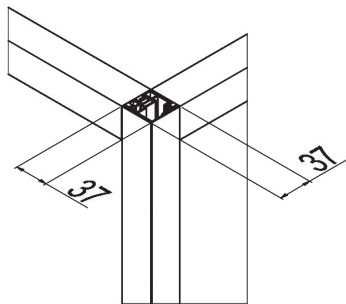
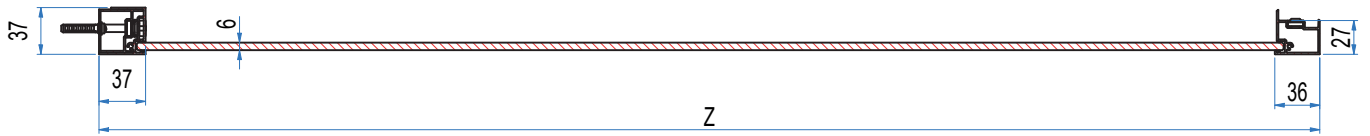

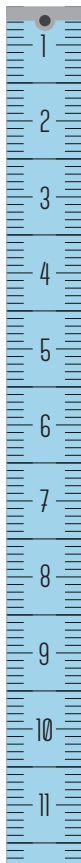

Prodotti Speciali - Produits Spéciaux - Special products - Productos Especiales - Sonderfertigungen - Maatwerk - Специальные Иродукты

MISURE LIMITE	Altezza max 210 cm.	Larghezza max 120 cm.	Larghezza min 20 cm.	
MESURES LIMITES	Hauteur max 210 cm.	Largeur max 120 cm.	Largeur min 20 cm.	
LIMITS OF MEASUREMENTS	Height max 210 cm.	Width max 120 cm.	Width min 20 cm.	
MEDIDAS LIMITE	Altura max 210 cm.	Anchura max 120 cm.	Anchura min 20 cm.	
GRENZMAßE	Höhe max 210 cm.	Breite max 120 cm.	Breite min 20 cm.	
EXTREME MATEN	Hoogte max 210 cm.	Breedte max 120 cm.	Breedte min 20 cm.	
ПРЕДЕЛЬНЫЕ РАЗМЕРЫ:	Макс. высота 210 см	Макс. ширина 120 см	Мин. ширина 20 см	

	I								
	II								
	III								

DX

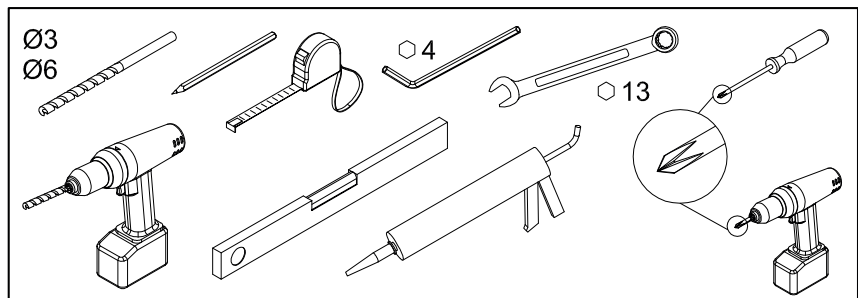
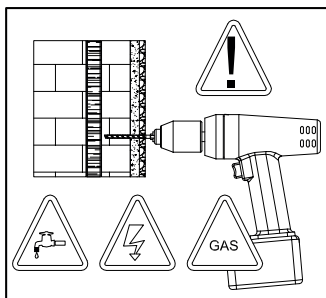
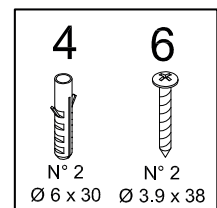
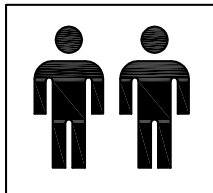
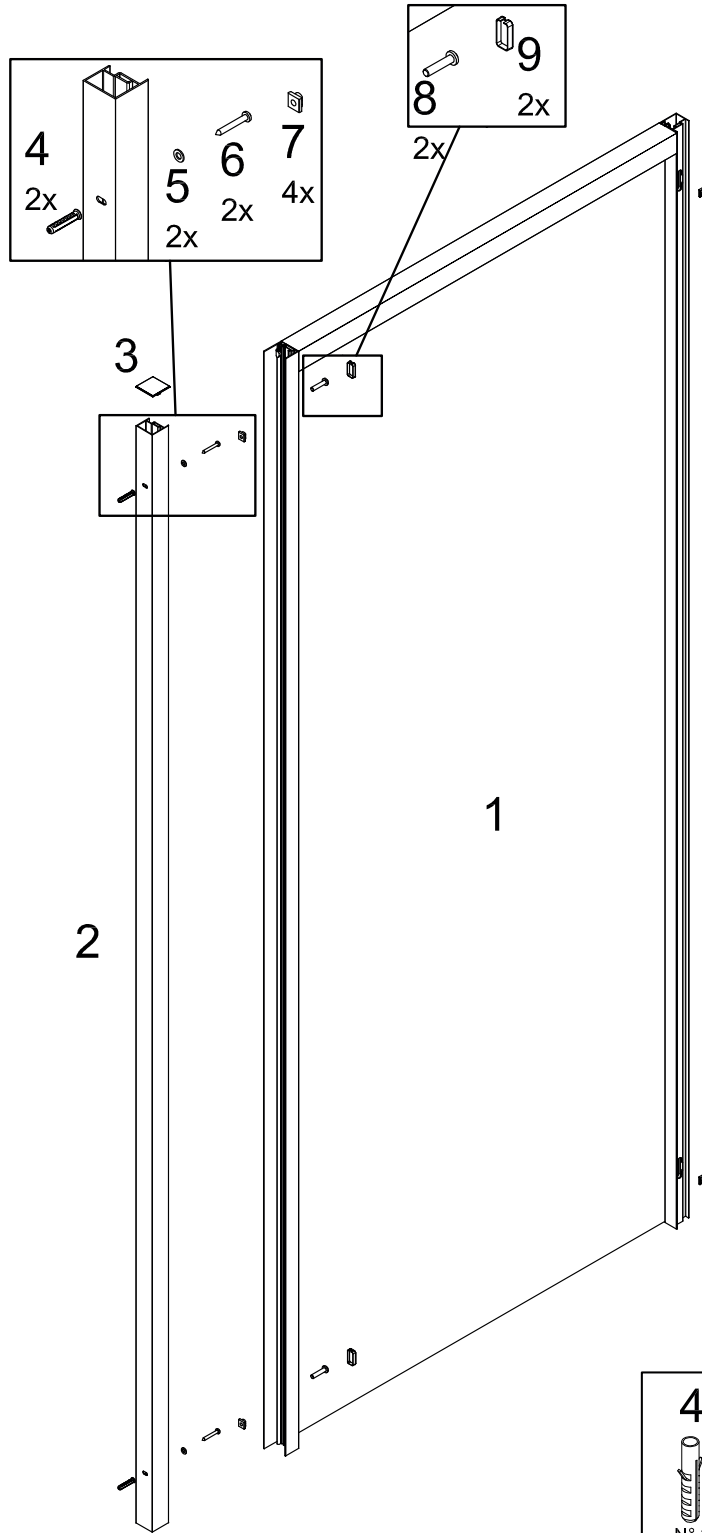

SX

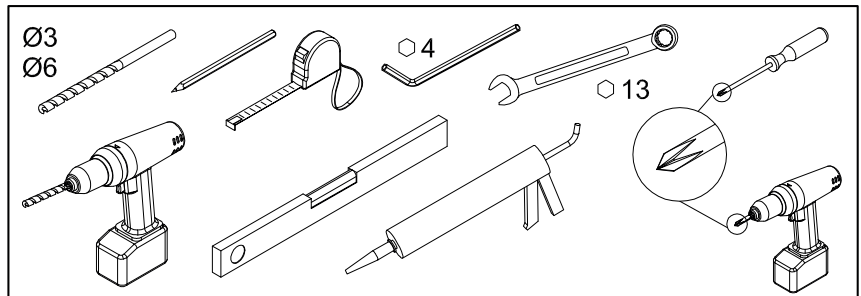
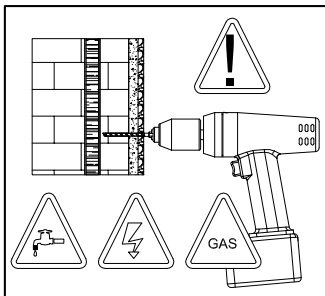
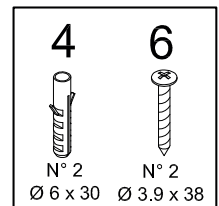
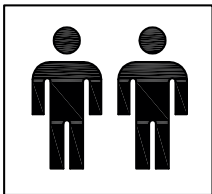
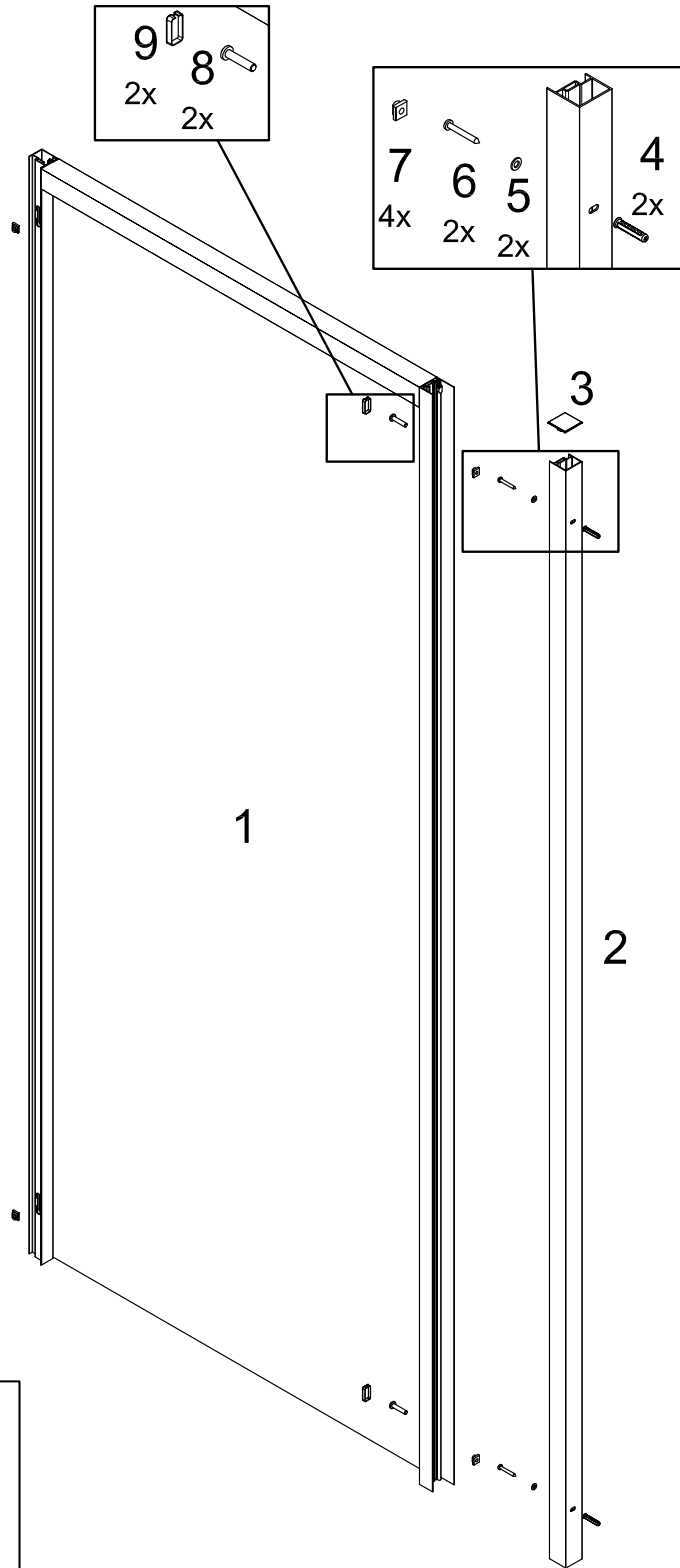

samo

