



FILO

GRIGLIE DOCCIA _ Shower baskets _ Paniers de douche _ Dushkörbe

Oggetti indispensabili per contenere in maniera organizzata tutto ciò che è utile per la cura del corpo.

Essential objects to contain and organize all body care items.

Objets essentiels pour ranger de manière organisée tout ce qui peut être utile pour le soin du corps.

Unverzichtbare Objekte für die organisierte Aufbewahrung all dessen, was der Körperpflege dient.

Finiture _ Finishes _ Finitions _ Afwerkingen

Acciaio inox cromato

Chromed stainless steel

Acier inoxydable chromé

Verchromter Poliert Edelstahl



.29







FILO

50003

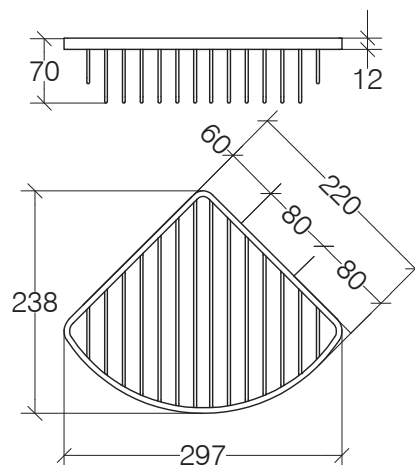
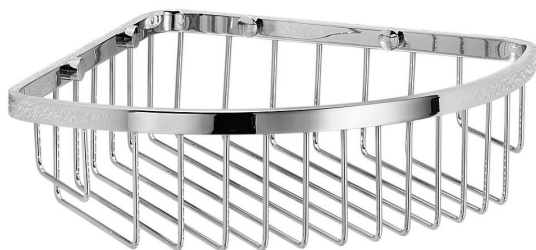
Griglia doccia angolare

Corner shower basket / Panier douche angulaire / Seifenablage eckig



cod. 50003	 KG	 dm³		Acciaio inox cromato Chromed stainless steel Acier inox chromé Verchromter Poliert Edelstahl
EAN 8005049009184	0,828	5,580	1	

Peso e volume lordo / Gross weight and volume / Poids et volume brut / Bruttogewicht und Volumen

PULIZIA e MANUTENZIONE

Pulire con un sapone neutro, applicare con un panno umido, strofinare leggermente, lasciar agire brevemente e quindi sciacquare con acqua. Infine lucidare con un panno morbido e asciutto. Per macchie di calcare pulire con una soluzione di acqua (80%) e aceto bianco (20%), per un'azione igienizzante aggiungere alla soluzione del bicarbonato di sodio. Asciugare sempre la superficie in modo da evitare le macchie derivanti dall'acqua.

Avvertenze: La resistenza alla corrosione al nichel-cromo si riduce sotto l'azione di acidi e composti alogenati (cloruri, bromuri, ioduri). Non utilizzare mai soluzioni a base di cloro (candeggina), detersivi o spugne abrasive. Evitare la ruggine causata da materiali esterni (ad es. paglietta di acciaio ecc.).

CARE and MAINTENANCE

Clean with a mild soap, apply with a damp cloth, rub lightly, leave it briefly and then rinse with water. Finally polish with a soft, dry cloth. To remove the limestone stains, clean with a solution of water (80%) an white vinegar (20%), to sanitize add baking soda. Always dry the surface in order to prevent stains caused by water. Warnings: The corrosion resistance of the steel is reduced by acids and halogen compounds (chlorides, bromides, iodides). Never use solutions containing chlorine (bleach), detergents or abrasive sponges. Prevent rust caused by external materials (eg. Scouring steel, etc..).